

Cooling	
Tolerance	f8
Coating	AlphaDura Navy

Strategy	HSC
Application	
Features	HA 1xD R



- Ultrafine carbide grade specially developed for machining hardened steels
- Adapted rake angle for safe milling up to 70 HRC
- Defined cutting edge preparation for homogeneous wear

- Radius tolerance $r \leq 2 \text{ mm}$: $\pm 0.003 \text{ mm}$
- Radius tolerance $r > 2 \text{ mm}$: $\pm 0.005 \text{ mm}$

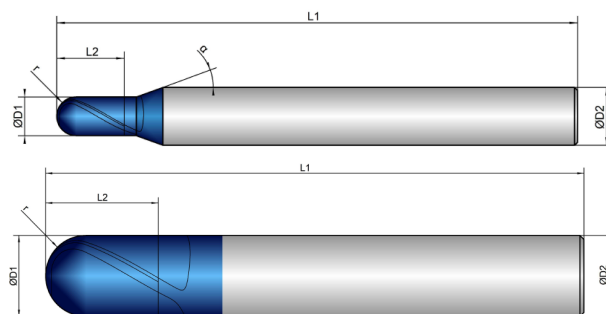
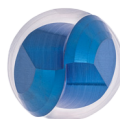

Roughing











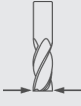

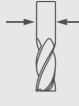



Finishing























	D1	L2	L1	D2	z	r	α
K203103	 mm \varnothing	 mm	 mm	 mm \varnothing	 #	 mm	 °
0,1/3	0.1	0.2	38.0	3.0	2	0.05	8
0,15/3	0.15	0.3	38.0	3.0	2	0.075	8
0,2/3	0.2	0.4	38.0	3.0	2	0.10	8
0,25/3	0.25	0.5	38.0	3.0	2	0.125	8
0,3/3	0.3	1.0	38.0	3.0	2	0.15	8
0,35/3	0.35	1.0	38.0	3.0	2	0.175	8
0,4/3	0.4	1.0	38.0	3.0	2	0.20	8
0,5/3	0.5	1.5	38.0	3.0	2	0.25	8
0,5/6	0.5	1.5	54.0	6.0	2	0.25	12
0,6/3	0.6	1.5	38.0	3.0	2	0.30	8
0,7/3	0.7	2.0	38.0	3.0	2	0.35	8
0,8/3	0.8	2.0	38.0	3.0	2	0.40	8

K203103 | ROWMAKER Z2 1XD SHORT ADN

K203103	D1	L2	L1	D2	z	r		α
	 mm ∅	 mm	 mm	 mm ∅	 #	 mm		
0,9/3	0.9	2.5	38.0	3.0	2	0.45	30	8
1/3	1.0	2.0	50.0	3.0	2	0.50	30	8
1/6	1.0	2.0	54.0	6.0	2	0.50	30	12
1,1/3	1.1	3.0	50.0	3.0	2	0.55	30	8
1,2/3	1.2	3.0	50.0	3.0	2	0.60	30	8
1,4/3	1.4	3.0	50.0	3.0	2	0.70	30	8
1,5/3	1.5	3.0	50.0	3.0	2	0.75	30	8
1,5/6	1.5	3.0	54.0	6.0	2	0.75	30	12
1,6/3	1.6	4.0	50.0	3.0	2	0.80	30	8
1,8/3	1.8	4.0	50.0	3.0	2	0.90	30	8
2/3	2.0	4.0	50.0	3.0	2	1.00	30	8
2/6	2.0	4.0	54.0	6.0	2	1.00	30	12
2,5/3	2.5	5.0	50.0	3.0	2	1.25	30	8
2,5/6	2.5	5.0	54.0	6.0	2	1.25	30	12
3/3	3.0	6.0	50.0	3.0	2	1.50	30	
3/6	3.0	6.0	54.0	6.0	2	1.50	30	12
4/4	4.0	7.0	54.0	4.0	2	2.00	30	
4/6	4.0	7.0	54.0	6.0	2	2.00	30	12
5/5	5.0	8.0	54.0	5.0	2	2.50	30	
5/6	5.0	8.0	54.0	6.0	2	2.50	30	12
6/6	6.0	10.0	54.0	6.0	2	3.00	30	
8/8	8.0	12.0	59.0	8.0	2	4.00	30	
10/10	10.0	14.0	67.0	10.0	2	5.00	30	
12/12	12.0	16.0	74.0	12.0	2	6.00	30	
14/14	14.0	18.0	75.0	14.0	2	7.00	30	
16/16	16.0	22.0	83.0	16.0	2	8.00	30	
20/20	20.0	26.0	93.0	20.0	2	10.00	30	

		Dimension	Ø0.1	Ø0.15	Ø0.2	Ø0.25	Ø0.3	Ø0.35	Ø0.4	Ø0.5	Ø0.6	Ø0.7
		Infeed in mm	ae=0.05xD ap=0.05xD	ae=0.05xD ap=0.05xD	ae=0.05xD ap=0.05xD	ae=0.05xD ap=0.05xD	ae=0.05xD ap=0.05xD	ae=0.05xD ap=0.05xD	ae=0.05xD ap=0.05xD	ae=0.05xD ap=0.05xD	ae=0.05xD ap=0.05xD	ae=0.05xD ap=0.05xD
		Application										
Material	Hardness in HRC	Feed (mm/Z)	fz	fz	fz	fz	fz	fz	fz	fz	fz	fz
H	HARDENED STEEL	Vc (m/min)										
1.1	46-55	110	0.014	0.014	0.017	0.017	0.018	0.018	0.019	0.024	0.024	0.024
1.2	56-60	70	0.012	0.012	0.016	0.016	0.017	0.017	0.018	0.023	0.023	0.023
1.3	60-65	50	0.01	0.01	0.014	0.014	0.015	0.015	0.017	0.022	0.022	0.022
1.4	66-70	40	0.008	0.008	0.012	0.012	0.013	0.013	0.014	0.019	0.019	0.019





		Dimension	Ø0.8	Ø0.9	Ø1	Ø1.1	Ø1.2	Ø1.4	Ø1.5	Ø1.6	Ø1.8	Ø2
		Infeed in mm	ae=0.05xD ap=0.05xD	ae=0.05xD ap=0.05xD	ae=0.05xD ap=0.05xD	ae=0.05xD ap=0.05xD	ae=0.05xD ap=0.05xD	ae=0.05xD ap=0.05xD	ae=0.05xD ap=0.05xD	ae=0.05xD ap=0.05xD	ae=0.05xD ap=0.05xD	ae=0.05xD ap=0.05xD
		Application										
Material	Hardness in HRC	Feed (mm/Z)	fz	fz	fz	fz	fz	fz	fz	fz	fz	fz
H	HARDENED STEEL	Vc (m/min)										
1.1	46-55	110	0.026	0.029	0.03	0.03	0.033	0.033	0.034	0.034	0.036	0.036
1.2	56-60	70	0.025	0.025	0.029	0.029	0.032	0.032	0.033	0.033	0.035	0.035
1.3	60-65	50	0.024	0.024	0.028	0.028	0.03	0.03	0.032	0.032	0.034	0.034
1.4	66-70	40	0.021	0.021	0.024	0.024	0.026	0.026	0.028	0.028	0.03	0.03

		Dimension	Ø2.5	Ø3	Ø4	Ø5	Ø6	Ø8	Ø10	Ø12	Ø14	Ø16
		Infeed in mm	ae=0.05xD ap=0.05xD	ae=0.05xD ap=0.05xD	ae=0.05xD ap=0.05xD	ae=0.05xD ap=0.05xD	ae=0.05xD ap=0.05xD	ae=0.05xD ap=0.05xD	ae=0.05xD ap=0.05xD	ae=0.05xD ap=0.05xD	ae=0.05xD ap=0.05xD	ae=0.05xD ap=0.05xD
		Application										
Material	Hardness in HRC	Feed (mm/Z)	fz	fz	fz	fz	fz	fz	fz	fz	fz	fz
H	HARDENED STEEL	Vc (m/min)										
1.1	46-55	160	0.04	0.044	0.055	0.08	0.09	0.11	0.13	0.14	0.14	0.15
1.2	56-60	125	0.038	0.042	0.052	0.075	0.085	0.105	0.12	0.13	0.13	0.14
1.3	60-65	110	0.035	0.04	0.05	0.07	0.08	0.1	0.11	0.12	0.12	0.13
1.4	66-70	85	0.03	0.035	0.045	0.06	0.07	0.085	0.09	0.1	0.1	0.11

		Dimension	Ø20
		Infeed in mm	ae=0.05xD ap=0.05xD
		Application	
Material	Hardness in HRC	Feed (mm/Z)	fz
H	HARDENED STEEL	Vc (m/min)	
1.1	46-55	160	0.18
1.2	56-60	125	0.17
1.3	60-65	110	0.15
1.4	66-70	85	0.13

EXPLANATION

























APPLICATIONS

 Multipass milling	 Trimming	 Deburring	 Engraving
 Corner rounding	 Full slot milling	 Forward and backward deburring	





COOLINGS

 Air-cooling	 Dry machining	 Oil cooling	 Cooling Lubricant
 Minimum quantity lubrication			

FEATURES

















 0,5xD	 1xD	 1,5xD	 2xD
 2,5xD	 3xD	 3,5xD	 4xD
 5xD	 Center cutting	 Non-center cutting	 Without Weldon
 With Weldon	 Internal cooling	 Dynamic helical pitch	 Chip breaker
 Unequal tooth pitch	 Roughing teeth	 Helical immersion	 Feed directions x,y
 Feed directions x, y, z	 Feed directions x, y, (z)	 Corner radius	 Corner bevel
 Sharp edged			

STRATEGY

 Extended Trochoidal Cutting	 High Performance Cutting	 High Speed Cutting	 Multi Task Cutting
 Universal Machining			



PROPERTIES

 Cutting diameter	 Small cutting diameter	 Large cutting diameter	 Undercut diameter
 Cutting length	 Total bevel length	 Undercut length	 Total length
 Shank diameter	 Number of teeth	 Corner radius	 Corner bevel
 Programming radius	 Maximum cutting depth	 Helical angle	 Alpha angle

APPLICATION TABLE

The values given in the application table are only guidelines. These values are largely dependent on the machining situation and application.

FIGURES

All technical drawings and photographs are given as an example. The product may deviate from the original in terms of colour and dimensions.

H 1.1-1.4 HARDENED STEEL | 46-70 HRC

Materialnummer	Germany DIN	Europe EN	France AFNOR	Great Britain BS	Italy UNI	Sweden SIS	Spain UNE	Japan JIS	USA AISI
1.2311	40CrMnMo7			BP 20	35 CrMo 8 KU				P 20
1.2312	40CrMnMoS86		40 CMD 8						
1.2316	X36CrMo17	X 36 CrMo 17	X38CrMo 16 1		X 38 CrMo 16 1 KU		X 38 CrMo 16		D-4
1.2365	X32CrMoV33	X 32CrMoV 12 28	32 DCV 28	BH 10	30 CrMoV 12 27 KU		F.5313	SKD 7	H 10
1.2567	X30WCrV53	X 30 WCrV 5 3	Z 32 WCV 5		X 30 WCrV 5 3 KU			SKD 4	
1.2581	X30WCrV93	X 30 WCrV 9 3	Z 30 WCV 9	BH 21	X 30 WCrV 9 3 KU		X 30 WCrV 9	SKD 5	H 21
1.2738	40CrMnNiMo864		40 CMND 8				F.5303		
1.2885	X32CrMoCoV333		30 DCKV 28						
1.4028	X30Cr13	X 30 Cr 13	Z 30 Cr 13	420 S 45	X 30 Cr 13	2304	X 30 Cr 13	SUS 420 J2	420
1.4031	X40Cr13	X 40 Cr 13	Z 40 C 14		X 40 Cr 14	2304	X 40 Cr 13	SUS 420	420
1.4034	X45Cr13	X 45 Cr 13	Z 40 C 14	420 S 45	X 40 Cr 14		X 46 Cr 13		420
1.4112	X90CrMoV18	X 90 CrMoV 18	Z 3 CT 1 2	409 S 1 9	X 6 Cr Ti 1 2			SUS 440 B	440 B
1.5122	37 MnSi 4		38 MS 5						
1.6358	X2NiCoMoTi 1895								
1.6582	34CrNiMo6		35 NCD 6	817 M 40	35 NiCrMo 6 (KW)	2541	F.1270	SNCM 447	4340
1.7003	38 Cr 2		38 C 2	120 M 36	38 Cr 2		F.1200		
1.7006	46 Cr 2		45 C 2		4 5Cr 2				5045
1.7030	28 Cr 4			530 A 30					5130
1.7176	55 Cr 3		55 C 3	525 A 58	55 Cr 3	2253	F.1431	SUP 9	5155
1.0961	60SiCr7	60 SiCr 8	60 SC 7	250 A 61	60 SiCr 8		60 SiCr 8	SUP 7	9262
1.1248	Ck 75		XC 75	060 A 78		1774			1078
1.1273	90Mn4			060 A 96				SUP 4	1090
1.2083	X42Cr13	X 42 Cr 13	Z 40 C 14		X 41 Cr 13 KU	2314		SUS 420 J2	420
1.2323	48CrMoV67		45 CDV 6						
1.2343	X38CrMoVH1	X 38 CrMoV 5 1	Z 38 CDV 5	BH 11	X 37 CrMoV 5 1 KU		X 37 CrMoV 5	SKD 6	H 11
1.2367	X38CrMoV53		Z 38 CDV 5 3						
1.2510	100 MnCrW 4		90 MWCV 5	B0 1	95 MnWCr 5 KU	2140	F.5220	SKS 3	0 1
1.2542	45WCrV7	45 WCrV 8		BS 1	45 WCrV 8 KU	2710	45 WCrSi 8		S1
1.2550	60 WCrV 7		55 WC 20		55 WCrV 8 KU				
1.2606	X37CrMoW51		Z 35 CWDV 5	BH 12	X 35 CrMoW 05 KU		F.537	SKD 62	H 12
1.2711	54 NiCrMoV		55 NCDV 6						
1.2713	55 NiCrMoV 6		55 NCDV 7				F.520.S	SKT 4	L 6
1.2764	X19NiCrMo4								
1.2767	X45NiCrMo4	40 NiCrMo 4	Y 35 NCD 16		42 NiCrMo 15 7 KU				A 9
1.4109	X65CrMo14	X 70 CrMo 15	Z 70 CD 14					SUS 440 A	440 A
1.1157	40Mn4		35 M 5	150 M 36					1039
1.1231	Ck 67		XC 68	060 A 67	C 70	1770			1070
1.1274	Ck 101		XC 100	060 A 96		1870		SUP 4	1095
1.2080	X210Cr12		Z 200 C 12		X 210 Cr 13 KU			SKD 1	D 3
1.2101	62SiMnCr4								
1.2162	21MnCr5	21 MnCr 5	20 NC 5					SCR 420 H	
1.2201	X165CrV12								
1.2210	115CrV3	107 CrV 3 KU	100 C 3		107 CrV 3 KU		F.520.L		L2
1.2341	X6CrMo4								
1.2379	X155CrVMo121	X 153 CrMoV 12	Z 160 CDV 12	BD 2	X 155 CrVMo 12 1 KU	2310		SKD 11	D 2
1.2419	105WCr6	105 WCr 5	105 WC 13		107 WCr 5 KU	2140	105 WCr 5	SKS 31	
1.2601	X165CrMoV12	X 165 CrMoV 12			X 165 CrMoW 12 KU	2310	X 160 CrMoV 12		
1.2721	50NiCr13								
1.2735	15NiCr14		10 NC 12					SNC 22	
1.2833	100V1		Y1 105 V	BW 2	102 V 2 KU			SKS 43	W 210
1.2842	90MnCrV8	90 MnV 8	90 MV 8	BO 2	90 MnVCr 8 KU				0 2
1.3505	100Cr6		100 C 6	534 A 99	100 Cr 6	2258	F.1310	SUJ 2	52100
1.4125	X105CrMo17		Z 100 CD 17		X 105 CrMo 17			SUS 440 C	440 C
1.8161	58CrV4								
1.1520	C70W1								
1.2363	X100CrMoV51	X 100 CrMoV 5 1	Z 100 CDV 5	BA 2	X 100 CrMoV 5 1 KU	2260	X 100 CrMoV 5	SKD 12	A 2
1.2436	X210CrW12	X 210 CrW 12	Z 210 CW1 2		X 215 CrW 12 1 KU	2312	X 210 CrW 12	SKD 2	
1.2880	X165CrCoMo12								
1.3202	S12145	HS12-1-5-5		BT 15	HS 12-1-5-5		12-1-5-5		T 15
1.3207	S104310	HS10-4-3-10	Z130WKCDV10-10-04-04	BT 42	HS 10-4-3-10		10-4-3-10	SKH 57	M 44
1.3243	S6525	HS6-5-2-5	KCV 06-05-05-04-02		HS 6-5-2-5	2723	6-5-2-5	SKH 55	M 35
1.3246	S7425	HS1-8-1	Z110 WKCDV 07-05-04	T 11341	HS 7-4-2-5		7-4-2-5		M 41
1.3247	S21018	HS2-9-1-8	Z110 DKCWV 09-08-04	BM 42	HS 2-9-1-8		2-10-1-8		M 42
1.3249	S2928			BM 34			2-9-2-8		

Materialnumber	Germany DIN	Europe EN	France AFNOR	Great Britain BS	Italy UNI	Sweden SIS	Spain UNE	Japan JIS	USA AISI
1.3257	S181215								
1.3333	S332	HS 3-3-2			HS 3-3-2				
1.3343	S652	HS6-5-3	Z85 WDCV 06-05-04-02	BM 2	HS 6-5-2	2722	6-5-2	SKH 51	M2
1.3344	S653		Z120 WDCV 06-05-04-03				6-5-3	SKH 52	M 3 Cl.2
1.3346	S291	HS1-8-1	Z85 DCWV 08-04-02-01	BM 1	HS 1-8-1				M1
1.3348	S292	HS2-9-2	Z100 DCWV 09-04-02-02		HS 2-9-2	2782	2-9-2		M 7
1.3355	S1801	HS18-0-1	Z80 WCV 18-04-01	BT 1	HS 18-0-1		18-0-1	SKH 2	T 1
1.1654	C 110 W								

Technical formulas

Calculate cutting speed (m/min)

$$V_c = \frac{D \cdot \pi \cdot n}{1000}$$

Calculate rotational speed (rpm)

$$n = \frac{V_c \cdot 1000}{D \cdot \pi}$$

Calculate feed rate (mm/min)

$$V_f = n \cdot z \cdot f_z$$

Calculate feed per tooth (mm/number of teeth)

$$f_z = \frac{V_f}{n \cdot z}$$

Calculate chip removal rate (cm³/min)

$$Q = \frac{a_p \cdot a_e \cdot V_f}{1000}$$

Calculate average chip thickness (mm)

$$h_m = f_z \cdot \sqrt{\frac{a_e}{D}}$$

Explanation of terms

V_c	Cutting speed	in m/min
n	Rotational speed	in rpm
V_f	Feed rate	in mm/min
F_z	Feed per tooth	in mm/number of teeth
z	Number of teeth (cutting)	
a_p	Depth of cut	in mm
a_e	Width of cut	in mm
h_m	Average chip thickness	in mm
Q	Chip removal rate	in cm ³ /min
D	Diameter of tool	in mm